

ROIDMI Self-Cleaning and Emptying Robot Vacuum Manual

Carefully read all the instructions before using this appliance. Keep it well for future reference



Scan the QR code for manuals
in multiple languages

ROIDMI

Contents

Safety precautions	
Warning (Robot cleaner)	2
Warning (Base station)	3
Product Introduction	
Robot cleaner	4
Dust box	4
Base station	5
Product use	
Quick product installation and use	5
APP installation and use	
ROIDMI APP Installation	7
Mi Home APP Installation	7
Product Operation and Programming	8
Base station display functions introduction	9
Base station status indicators	9
Product disassembly and cleaning	
Roller brush assembly, disassembly and cleaning	10
Side brush removal and cleaning	10
Removal and cleaning of dust box and filter element	11
Mop disassembly and cleaning	12
Robot cleaner part cleaning	12
Base station cleaning	13
Cleaning the base station parts	14
Troubleshooting	14
Common problems	16
Basic specifications	17
Disposal	18
Warranty and limitations of liability	18
Warranty card	19
Maintenance records	19

Safety Precautions

Carefully read the instruction manual before use

Warning: Carefully read the following safety precautions before use in order to avoid causing harm to yourself and others or property damage. The safety precautions are divided into 2: "Warning" and "Caution" are important instructions for safe use of the appliance be sure to follow them.

Hereby, [ROIDMI INFORMATION TECHNOLOGY CO., LTD.] declares that the radio equipment type [2.4GHz WLAN Module] is in compliance with Directive 2014/53/EU. The full text of the EU declaration of conformity is available at the following internet address: http://doc.roidmi.com/web/#/27?page_id=0

 **WARNING** Precautions that may cause death or serious injury as a result of incorrect operation

 **Caution** Cautions that may cause minor injuries or damage to the product due to incorrect operation

 **Warning (Robot cleaner)**

1. Do not use this appliance on wet surfaces such as near water sources, bathrooms etc;
2. Do not use the appliance to clean up liquids, cigarettes, matches or wet garbage;
3. Do not use the appliance to clean flammable liquids such as kerosene, gasoline; objects with sparks, toner cartridges, toners and other combustible dust or use the appliance near the any of the above items or flammable and explosive gases to avoid fire;
4. Do not disassemble, repair, or modify by yourself, so as to avoid causing fire, injury, or poor operation, except for the replacement of consumables according to this manual;
5. If the roller brush is abnormal during use, please switch off the appliance and immediately check whether the roller brush is entangled with hair, fibers or other windings and clean it up;
6. The battery is sealed and poses no safety hazard under normal circumstances. Under extreme conditions, if liquid leaks out of the battery it may cause irritation or burns. ①If touch accidentally occurs to skin, clean the skin immediately with lots of soap and water. ②If touch with eyes occurs, immediately rinse with water for at least 15 minutes and seek medical help;
7. The appliance is not to be used by persons (including children) with reduced physical, sensory or mental capabilities, or lack of experience and knowledge, unless they have been given supervision or instruction. Children being supervised can not play with the appliance.
8. Please keep the appliance away from electromagnetic equipment in the hospital;
9. Children should not be allowed to use this appliance as a toy;
10. This appliance can only be used with the cleaning base station provided by the manufacturer;
11. Before disposing of the machine, remove the battery from the machine. Power off the machine before removing the battery. The correct tools are required to take out the battery. To open the bottom cover of the appliance and remove the screws firstly, then proceed to unplug the battery connection terminal and take out the battery. The used battery pack should be safely recycled and not carelessly disposed of;
12. When the appliance is stored for a long time and is not in use, it is recommended to charge it once a month.
13. This appliance can be used by children aged from 8 years and above and persons with reduced physical, sensory or mental capabilities or lack of experience and knowledge if they have been given supervision or instruction concerning use of the appliance in a safe way and understand the hazards involved

Warning (Base station)

1. Do not plug in or handle the power cord, plug or appliance with wet hands;
2. Do not use damaged power cords or loose sockets;
3. When charging the base station, please use AC power with rated voltage. Do not use generators or DC power supplies to avoid fire and electric shock;
4. Use a dry cloth to regularly clean dust off the plug to avoid fire due to poor insulation;
5. Be sure to correctly and firmly insert the plug into the socket to avoid electric shock, short circuit or fire;
6. In the event of abnormal failure, please immediately cut off the power supply and stop using it to prevent smoke, electric shock or fire;
7. In event, the base station body deforms, abnormally heats-up, smells burnt or makes abnormal noises while in use, please immediately cut off the power, unplug it and place the product in an open area, free of combustible materials. To ensure safety, any replacement or maintenance should only be carried out by the manufacturer orROIDMI designated maintenance personnel;
8. Be sure to unplug the appliance from the power source before cleaning and maintenance to avoid electric shock or injury;
9. Do not spray water on or immerse the appliance or power cord in water;
10. Do not use other power cords to charge the appliance;
11. When removing the unplugging the base station, be sure to hold the insulated part of the plug and do not pull the power cord to avoid risk of electric shock;
12. If the body of the base station is damaged, please do not use to clean the base station to avoid the risk of electric shock;
13. This base station is for use only with the robot cleaner designated by the manufacturer;
14. Before charging, ensure that the required power voltage of the base station is consistent with power supply voltage.
15. Do not charge non-rechargeable batteries.
16. Only use the specified power cord to connect to the outlet.

Notice (Robot cleaner/Base station)

1. Do not use both the robot cleaner or the base station in outdoor, non-floor, commercial or industrial environments;
2. Do not use in an open environment where there is no protective roof covering;
3. Do not block the exhaust port, so as to prevent appliance body deformation, failure or fire due to overheating;
4. Do not drag the machine, so as not to scratch the base;
5. Do not swing the appliance or allow children to play with it to avoid causing injury or damage to the machine;
6. Do not drop, collide the appliance with other objects, or apply any form of pressure to the machine, so as to avoid malfunctions that could cause electric shock or fire;
7. Install the roller brush and filter element before use, to avoid affecting the cleaning performance of the machine;
8. Please check if the charging cable of the clean base station is well connected before charging;
9. Before using the robot cleaner, clear the area to be cleaned. Arrange the furniture and other household items neatly and remove power cords and small items from the ground to prevent the obstruction of the appliance during cleaning;
10. When the appliance is in operation, keep the carpet flat to avoid blocking the appliance during operation;
11. Do not stand in front of the robot cleaner while it is cleaning, lest the host cannot identify the area to be cleaned;
12. Do not use and store the appliance under extreme adverse conditions, such as extreme temperatures, etc. It is recommended to use it at an indoor ambient temperature, please store it in a cool and dry place;
13. When using the cleaning solution, avoid contact with eyes. If contact with eyes accidentally occurs, rinse thoroughly with water. Do not swallow or mix with other cleaning agents, chemicals, and medicine.
14. The plug must be removed from the socket-outlet before cleaning or maintaining the appliance

Product Introduction

Robot Cleaner

EN

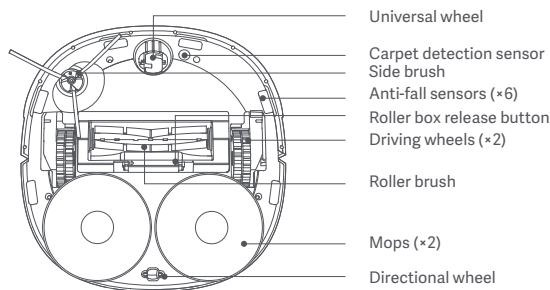
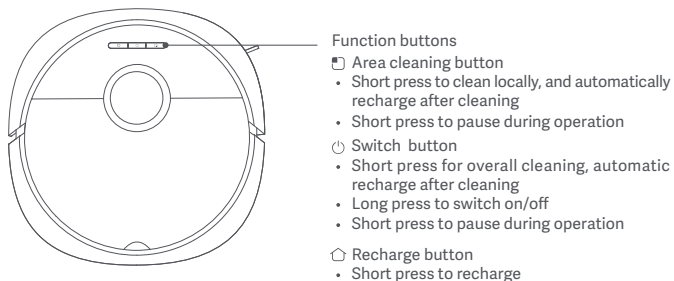
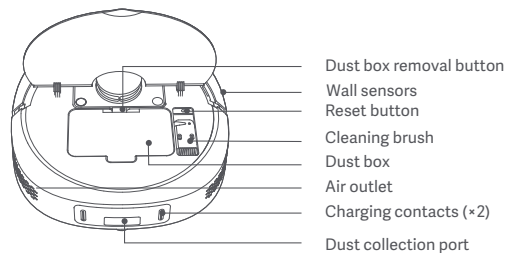
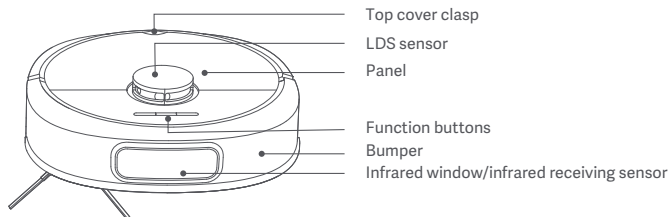

Dust box

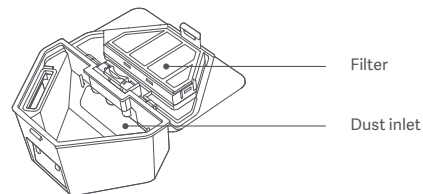
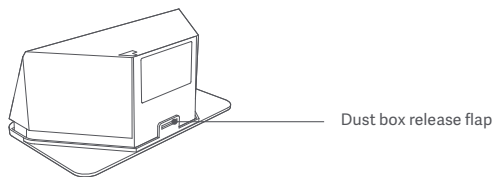

Base station

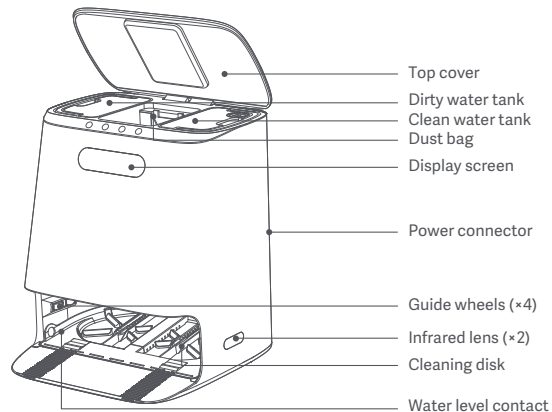
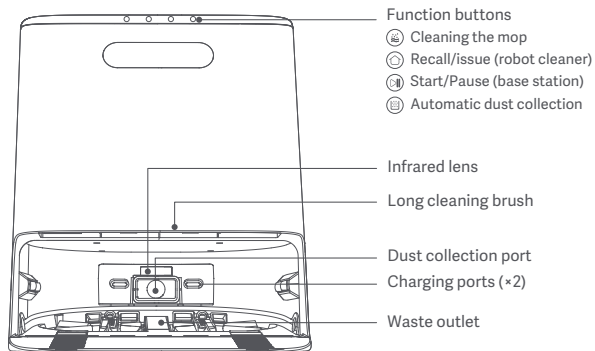

Product use

Quick product installation and use

Step 1: Remove the protective material from the limit strips on both sides of the bumper;

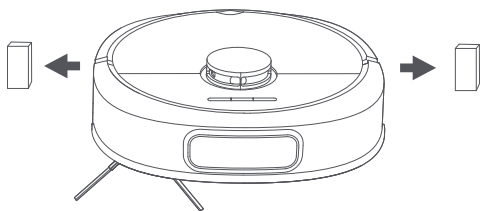

Step 2: Paste the mop on the mop support sticking area and install the mop support component into the bottom groove;

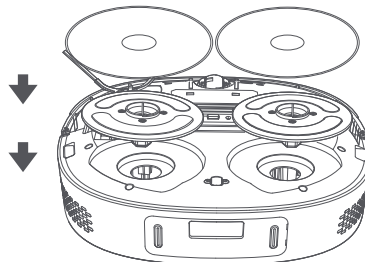

Step 3: Find a suitable location to place the base station and ensure that it is placed horizontally;

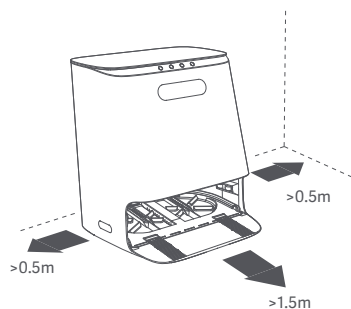

Step 4: Take out the clean water tank, remove the lid and fill it with clean water (the water volume should be below the MAX line). Then put back the clean water tank into the base station and cover the base station;

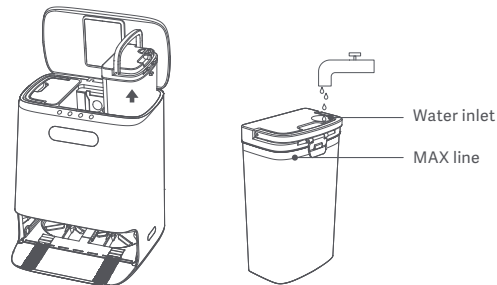

Step 5: Connect the base station to the power supply as shown in the figure below, press the recharge button to actively search for the robot cleaner for charging.

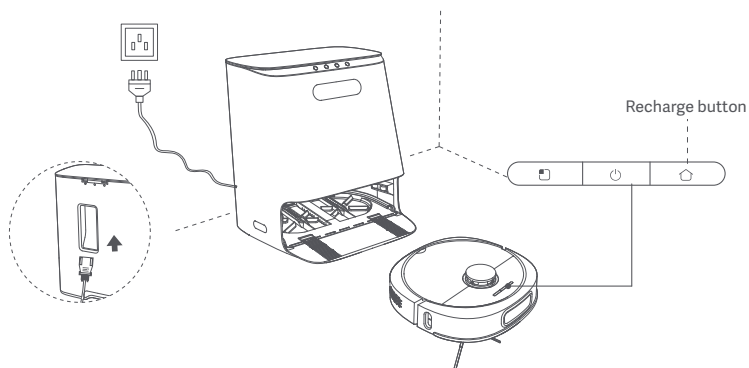

*Power cord model: (China: PC323L+LS-60; United Kingdom: AW301+AW104; Korea: AW103+AW104; United States: DHT13+DHT35; Japan: DHT01+DH104; European Union: AW103+AW104; Australia: LP-23A+AW104)



Notice

1. Avoid using this appliance around infants or pet rooms and keep it away from infants and pets to avoid danger;
2. In order to facilitate the appliance to smoothly return to the base station after cleaning, it is recommended that the cleaning start-point be from the base station. Do not manually move the clean base station during the cleaning process;
3. The base station has the functions of collecting dust, charging, cleaning and air-drying the mop. A new dust bag has already been installed before leaving the factory;
4. The base station should be placed horizontally on a non-carpet floor that is more than 1.5m away from the carpet;
5. When the map is first started, the appliance starts from the base station to improve the efficiency of map creation.

App installation and use

ROIDMI APP Installation

This appliance is compatible with the ROIDMI Platform, and can be controlled by the "ROIDMI" App. It supports both Android and iOS systems.

1. Scan the QR code below or search for "ROIDMI" on the app store to download and install;
2. Sign in to the app. Long press  and  buttons on the robot cleaner at the same time for longer than 3 seconds to reset it. Click "+" at the upper right on the app's homepage to add device. Select the robot cleaner from the device list and connect it to WiFi according to the prompts.

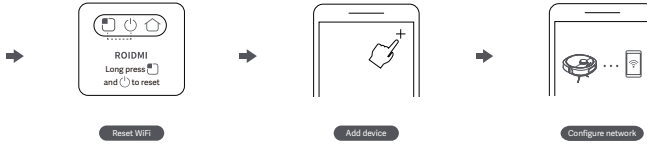



* This product only supports 2.4GWiFi

3. If you have any questions, please consult customer service or check the official website.

Mi Home APP

This product works with mijia (Mi Home). It can be controlled via Mi Home app and interconnected with other smart devices.

1. Scan the QR code below, or search for "Mi Home" in the app store to download and install the app;
2. Turn on Mi Home app, register an account or sign in to the app;
3. Long press  and  buttons on the robot cleaner at the same time for longer than 3 seconds to reset it. Click "+" at the upper right on the app's homepage to add device;
4. In the device category list find the "Robot Cleaner" category, then click your ROIDMI robot cleaner model to enter Network Configuration interface;
5. Perform follow-up operations according to the app's prompts on network configuration.

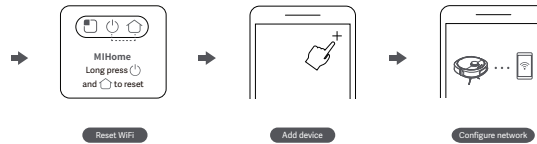

Reminder: Actual operations may vary due to upgrade and update of Mi Home app. Please follow the instructions in the app.

Please note that "works with mijia" only certifies the product is compatible with Mi Home app.

Xiaomi and Mijia are not liable for any problems related to the product itself and its manufacturer's production, executive standards, quality control, etc.

* Some overseas regions do not support connection to Mi Home APP

Product Operation and Programming

1. Powering on/off the appliance

Power on: long press the switch button, the switch button indicator lights up and the appliance enters standby state.

Shut down: long press the switch button, the indicator light slowly goes out and shutdown.

2. Charging

After cleaning, the robot cleaner will automatically return to clean the base station and recharge. If the robot cleaner does not start cleaning from the base station the recharge function may fail and you may need to manually place it on the base station.

When the robot cleaner is charging, the switch button is always on and the power-on/off indicator blinks when it is fully charged.

3. Overall cleaning

After the first cleaning, the robot cleaner will scan and partition the room into a smart map, and clean it according to the method of first along the walls and then in the bow shape. After the cleaning is completed the robot cleaner will automatically return to base station.

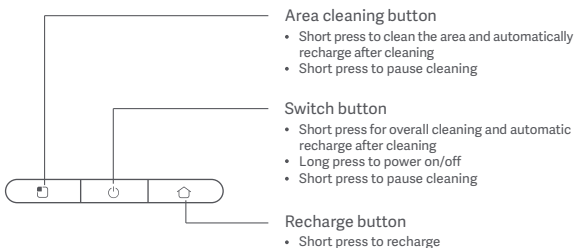

4. Cleaning a localized area

When the main unit is in Standby mode or paused, press the Spot button to start cleaning a localized area. The cleaning area is a 1.6 m x 1.6 m square centered on the main unit. After cleaning, the main unit automatically docks.

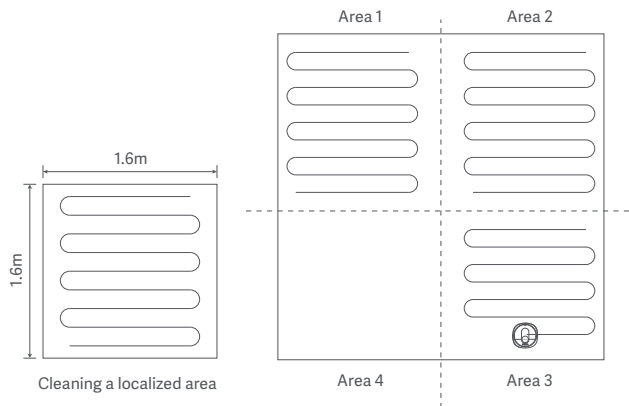

5. Operation failure

When there is an abnormality in the operation of the robot cleaner, the switch button indicator light flashes white quickly and voice broadcasts, please refer to this manual on how to troubleshoot the robot cleaner to solve abnormal problems.

6. Dormant

If there is no operation after more than 10 minutes, the robot cleaner will automatically enter the dormant state, press any key to restart.

7. Automatic dust collection

After the cleaning is completed, the robot cleaner will automatically return to the base station for charging and dust collection.

8. Reset button

When the button does not respond or doesn't power on, reset the system by pressing the reset button (see page 4 for details), the robot cleaner will automatically reset and start. after resetting the schedule, cleaning order and cleaning mode settings of the appliance will be cleared, and WiFi will be reset.

Note

1. It is recommended to place the robot cleaner in the base station charging position to start cleaning;
2. When the power is insufficient during the cleaning process, the robot cleaner will automatically return to the base station to recharge and return to the last break point to resume cleaning after sufficient power is replenished;
3. Before using the product, clear the area to be cleaned. Arrange the furniture and other household items neatly and remove power cords and small items from the ground to prevent the obstructions of the appliance during cleaning;
4. Do not stand in front of the appliance when it is cleaning, lest it cannot identify the area to be cleaned.

Base station display functions introduction

After the base station is connected to the power, the light strip is always on; when the dust is collected or in mop cleaning state, the light strip shows a gradient marquee light movement.

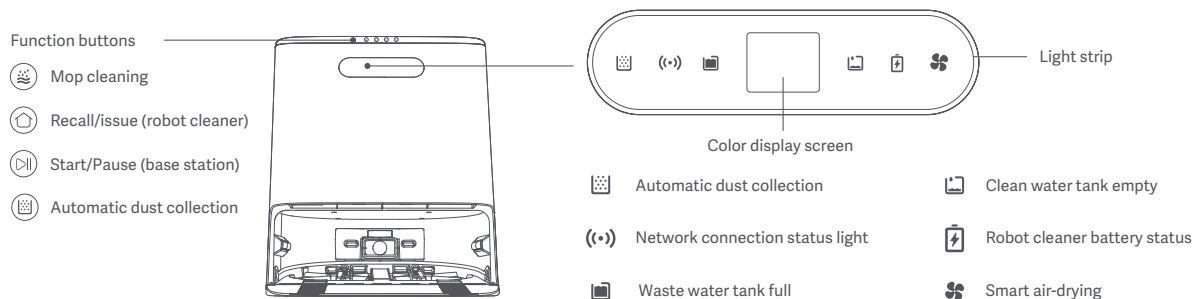

*Tip: Start by touching the button with your finger

Base station status indicator

Indicator light \ State	Running status display	
	Dust collection normal indicator light is always on	Dust full indicator flashes
	The connection is normal, the indicator light is always on	The connection is abnormal, indicator light flashes
	The waste water tank is not full, indicator light goes out	The waste water tank is full, indicator light is always on
	There is water in the clean water tank, indicator light goes out	The clean water tank empty, indicator light flashes
	Normal battery, the battery indicator light is off	Low battery, indicator light flashes
	The air-drying function works normally, indicator light is always on	The air-drying function is not activated, indicator light is off

Prompt: For other faults, please check the color screen for specific faults.

Product disassembly and cleaning

The following cleaning steps should be carried out when the appliance is switched off

Roller brush assembly, disassembly and cleaning

Step 1: Remove the roller brush

Turn the appliance over, press the roller brush cover release buttons simultaneously. Remove the roller brush cover, take out the roller brush and clean;

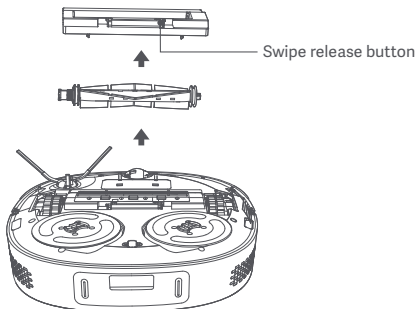

Step 2: Roller brush cleaning

Use a cleaning brush to clean and cut out the hair and fibers entangled on the roller brush. It is recommended to change the roller brush every 3-6 months.

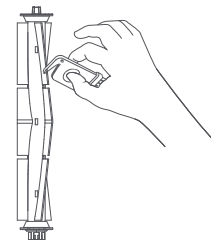

Side brush removal and cleaning

Step 1: Remove the side brush

Turn the appliance over, use a screwdriver to unscrew the screws and take out the side brush;

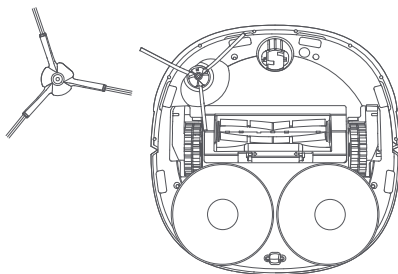

Step 2: Side brush cleaning

Use a cleaning brush to pick up and cut the hair and fiber attached to the side brush to separate it from the side brush. It is recommended to replace the side brush every 3-6 months. Replace the side brush once done cleaning to ensure the cleaning effect.

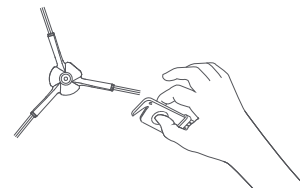

 Note

1. Please replace the side brush according to the original factory configuration, so as not to affect the cleaning effect;
2. Please use a screwdriver carefully when replacing the side brush, to avoid injuring yourself;
3. The cleaning brush has a sharp blade which is used to cut the windings that are difficult to clean. Keep it out of reach of children.

Removal and cleaning of dust box and filter element

Step 1: Remove the dust box

Open the top cover upwards, simultaneously press the dust box removal button, and take out the dust box;

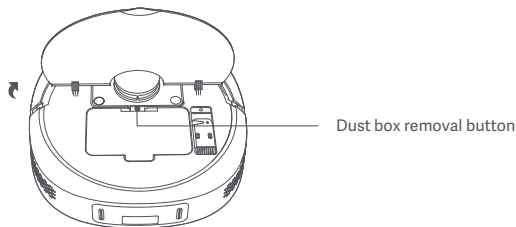

Step 2: Dump the dust box trash

Open the dust box, align the dust box on top of the trash can, and dump the dust. Clean the hard-to-reach corners with a cleaning brush;

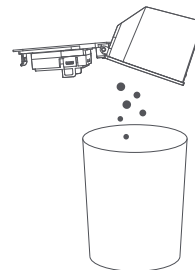

Step 3: Remove the filter element

The user can decide whether to clean the filter element according to his own use. Take out the filter element, Clean it with a cleaning tool and then reinstall it by the original order or replace it with a brand new filter element;

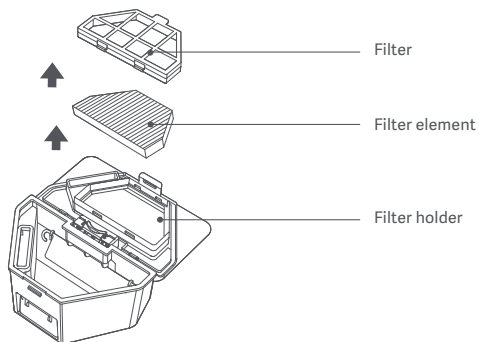

Step 4: Clean the dust box

Rinse the dust box/filter element with clean water. Replace it after it's completely dry to prevent dust from clumping and causing unpleasant odors when used again.

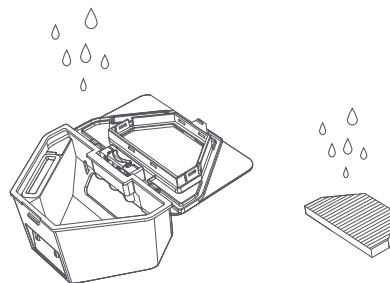

Mop disassembly and cleaning

Step 1: Remove the mop

Remove the mopping module from the disk and remove the mop from the mopping bracket;

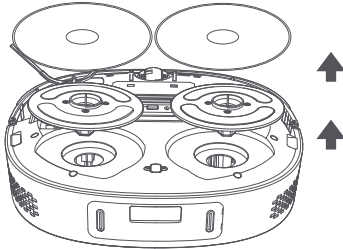

Step 2: Clean the mops

Rinse the mop with clean water and use it after it dries completely to prevent the dust from clumping and causing unpleasant odors when used again.

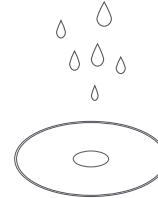

Note

1. Only replace with the original mop designated by the manufacturer, to avoid affecting the cleaning effect of the appliance due to product incompatibility;
2. Be sure to remove the mop for cleaning to prevent dirty water from overflowing;
3. It is recommended to replace the original mop every 3-6 months to ensure a better cleaning effect.

Robot cleaner part cleaning

Step 1: Cleaning the sensors

Wipe and clean the charging contacts, anti-fall sensors, LDS sensors, and infrared transmitters on the back of the robot cleaner with a soft clean cloth;

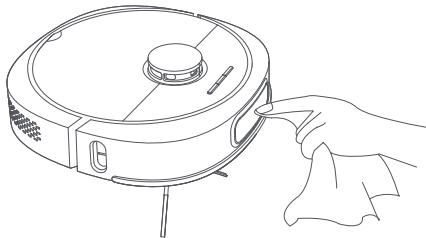

Step 2: Cleaning the universal wheel

Turn over the appliance and pull out the universal wheel to clean the hair and dirt on the wheel body and axle. The universal wheel can be washed with water, and then reinstall after complete drying.

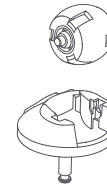

Note

1. When cleaning the anti-fall sensors, infrared sensor and charging contacts, please use a dry cloth to prevent damage caused by water;
2. Be careful when using a screwdriver to replace parts to avoid causing damage to the parts.

Base station cleaning

Step 1: Replacing the dust bag

When the dust bag is full, the dust-full indicator flashes. Replace the dust bag according to the display on the base station. It is recommended to replace it every 6-8 weeks;

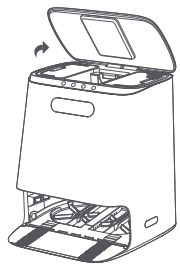

Open the top cover of the base station

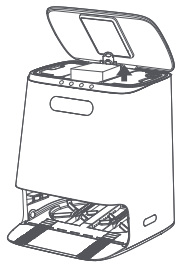

Take out the dust bag

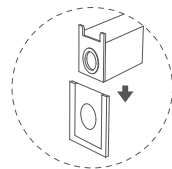

Insert the dust bag plate into the slot

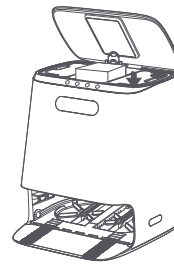

Replace with a new dust bag

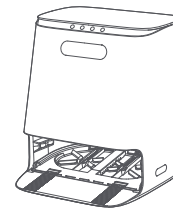

Close the top cover of the base station

Step 2: Cleaning the dust channel

In the power-off state, check whether there is any abnormal blockage on the transparent module of the dust channel and the dust inlet. If there is blockage, please clean up the wedged objects in time;

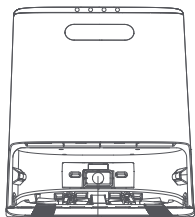

Dust channel transparent module

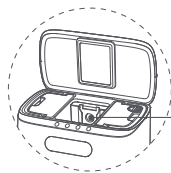

Dust inlet

Step 3: Clean the infrared lens and charging ports

Wipe and clean the infrared lens and charging ports with a soft clean soft cloth to ensure that it is clean and free of debris.

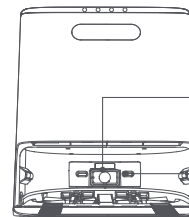

Infrared lens

Charging ports (*2)

Cleaning the base station parts

Step 1: Clean the waste water tank

Open the top cover of the base station, take out the waste water tank, open the waste water tank flap to pour out the dirty water and use a long cleaning brush to clean the dirt in the water tank. After cleaning and drying, put it back into the base station;

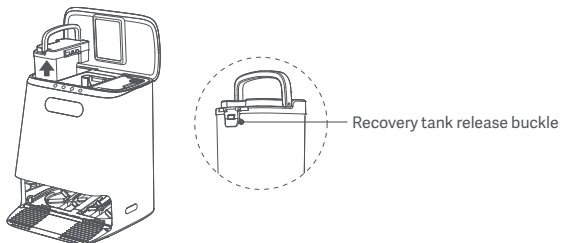

Step 2: Replace the filter sponge of the water purification tank

Open the top cover of the base station and take out the clean water tank. Then open the clean water tank flap and take out the filter sponge holder along the water pipe. Open the lower cover of the filter sponge holder, take out the filter sponge, replace with a new filter sponge and reinstall it;

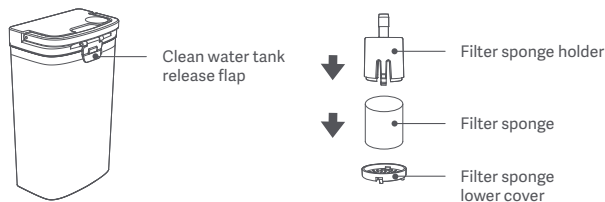

Step 3: Clean the cleaning plate/base

Press the cleaning mop button of the base station to discharge water 4 times, each time for 10 seconds, and then press the cleaning mop button once again to automatically suck back the sewage, use a long cleaning brush to clean the tray/base and put it back in the sun.

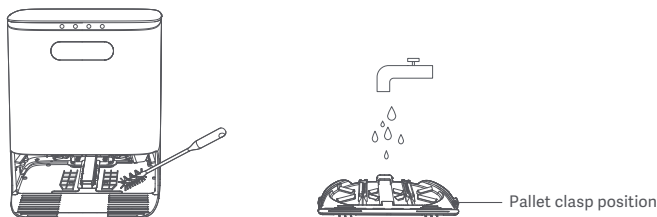

Troubleshooting

When an abnormality occurs during the operation, the switch key indicator light flashes quickly and a voice prompt is given. The following methods can be used to try to solve the fault by yourself. If the fault cannot be rectified, please contact the after-sales service.

Troubleshooting (Robot cleaner)	Solution
Error 1: Please check whether the radar is blocked and move to a new position to start or please check if the radar is stuck	Please check whether the radar is blocked or jammed by wedged objects, if this is the case please remove the foreign objects
	Please don't use it in places with strong light
	If the above does not work, please move the appliance to a new location to start
Error 2: Please check whether the obstacle avoidance sensor is jammed by debris, remove the debris, and tap the obstacle avoidance sensor several times to check whether it is flexible	Please check if the appliance is trapped due to too little running space and move it to a new location to start
	Please check whether the obstacle avoidance sensor is jammed by debris, remove the debris, and tap the obstacle avoidance sensor several times to check whether it is flexible
Error 3: Please wipe the anti-fall sensor and start away from the dangerous area	Please check if the appliance is suspended and move it to a new location to start
	Please check whether the anti-fall sensor is too dirty or blocked by dust or other debris. You need to wipe the anti-fall sensor regularly

Error 4: Please check if the roller brush is stuck	Please check whether the roller brush is entangled with wool, wires and other windings. Remove the roller brush and clean it
	Please check whether there are any entangled objects such as wool and wires/cords on the indoor floors and clean them up
	The roller brush may tangle and needs to be cleaned regularly
Error 5: Please check if the side brush is stuck	Please check whether the side brush is entangled with wool, wires or other debris. If so remove the roller brush and clean it
	Please check whether there are any entangled objects such as wool or wires on the indoor floor and clean it up
	The side brush may tangle and needs to be cleaned regularly
Error 6: Please check if the main wheel is stuck	Please check whether there is any debris stuck on the wheels and remove them
Error 7: Please put back the dust box	Please put back the dust box, make sure the filter and dust box are installed in place
	If the error is still reported after the installation is in place, please try to replace the filter
Error 8: Low battery, please charge	Low battery, please recharge before use
Error 9: Recharge failed, please check whether the connection between the appliance and the base station is normal	Please use a dry cloth to wipe the charging contacts of the appliance and the charging ports of the base station
Error 10: The battery temperature is abnormal, please try again later	The battery temperature is too high or the temperature is too low, please wait for the battery temperature to be normal before use
Error 11: Please check the right wall sensor	The wall sensor is blocked by dust, please wipe the wall sensor on the right
Error 12: Please place the machine on a level ground to start	The machine is detected to be tilted during startup, please place the machine on a level ground to restart
Error 13: The fan of the robot cleaner is abnormal	The vacuum fan is not working, please try to reset the system
Error 14: Please clean the filter	Please take out the filter inside the appliance to clean it

Troubleshooting (Base station)	Solution
Error 1: Recharge failed, please clear obstacles near the base station	Please clear the obstacles near the base station to ensure that there are no obstacles within 1.5 meters in front of the base station
Error 2: Please stay away from the restricted area before starting	Please move the machine away from the software virtual wall or restricted area and restart it
Error 3: Please check if the mop component is stuck	Please check whether the mop components are entangled or blocked and remove the wedged objects/entanglements
Error 4: Please reinstall the clean water tank	Please check if the clean water tank is in place or installed in place
Error 5: No water in the clean water tank	Please check the clean water tank, please fill up to the maximum MAX line of the clean water tank
Error 6: Please put back the waste water tank	Please check if the waste water tank is in place or installed in place
Error 7: The waste water tank is full	Please clean the waste water tank and reinstall it
Error 8: The waste water tank is abnormal	Please check if the waste water tank cover is closed
	Please check if the waste water tank is installed in place
	Please check whether the waste water suction port is blocked, please clean the waste water suction port regularly

Error 9: Please load the cleaning tray	Please check whether the cleaning tray is in place or installed in place, and reinstall the cleaning tray
Error 10: The dust bag is not in place, please check if its installed.	Please check if the dust bag is installed
	If the dust bag is installed, please check if the dust bag is inserted all the way
Error 11: The base station wind pressure is abnormal	Please check if the top cover of the base station is closed
	Please check if the dust bag is full and replace it in time
Error 12: The dust bag is full	If the dust bag is not full, please check whether the dust channel of the base station is blocked. If the dust channel of the base station is blocked, please try to clean the dust channel manually
Error 13: Abnormal dust collection	Please check whether there is any wedged objects in the dust collection port of the dust bag of the base station, please clean up the foreign matter in the dust collection port
	Please check if the dust box is blocked, please clean the dust box
Error 14: Standby	When returning to the base station while mopping the floor, the clean water tank is not in place or enters standby without water
	When the waste water tank is not in place or the water is full when it returns to the base station in the mopping state, it is not replaced and enters standby
	When returning to the base station in the mopping state, the cleaning disk is not in place and enters standby
	When returning to the base station, the washing tank is full and enters standby

Tip: Resetting the system can eliminate some abnormalities.

Common problems

Questions	Solution
Can not boot	If the battery is low, please charge it on the base station before using it; if the battery temperature is too low or too high, please use it at 0-40 C
Can't charge	The base station is not powered on, please make sure that both ends of the base station's power cord are plugged in. If the connection is not good, please clean the base station charging ports and the robot cleaner charging contacts; please make sure the base station display screen is on
Slow charging	When used in a high or low temperature environment, in order to extend the battery life, the robot cleaner will automatically reduce the charging speed; the charging contact area may be dirty, please clean the area with a dry cloth
Can't recharge	There are too many obstacles near the base station, please place the base station in an open area; the robot cleaner is too far away from the base station, please try to place the robot cleaner near the base station
Abnormal noise during cleaning	The main brush, side brush or main wheel may be entangled with foreign matter, please clean it after powering it off; the swivel wheel is dusty or entangled during cleaning, it is recommended to use a screwdriver to pry out and rinse it
Can't connect to WiFi	The Wi-Fi function is not activated, please reset the Wi-Fi and try again
	The Wi-Fi signal is not good, please make sure the robot cleaner is in a good Wi-Fi signal coverage area
	The Wi-Fi connection is abnormal, reset the Wi-Fi and download the latest app to try to connect again
	The APP does not support the current model of the device, please check the specific supported model according to the app prompt
	Wi-Fi suddenly fails to connect, and you suspect that the home router has a setting error, please contact after-sales service

Do you need to charge for sixteen hours for the first three uses	Lithium battery has no memory effect when used, no need to wait when it is fully charged
Insufficient battery during cleaning, recharge but not continued	Please make sure that the host is not in the Do Not Disturb mode, it will not continue scanning in this mode; manual recharging or putting the robot cleaner back to the base station will not continue scanning
Can not return return to the base station after partial cleaning or moving location	The robot will regenerate the map after area cleaning or long-distance movement. If the base station is far away, it may not be able to automatically recharge. Please manually put the robot back to the base station to charge
Missing sweep of robot cleaner	The wall sensor or the anti-fall sensor is dirty, it is recommended to wipe it with a soft dry cloth
Decreased cleaning ability	The dust box is full, please clean the dust box; the filter is blocked, please clean the filter; the roller brush is entangled with wedged objects, please clean the roller brush
Timed cleaning does not take effect	Timed cleaning will start when the remaining power charge is more than 15%
Whether it consumes electricity directly at the base station	When the machine is always in the base station, the battery consumption is low, which helps to keep the battery at its best performance
There is no water in the cleaning plate but the pump is still working	Need to clean and wipe the water level contacts
When the robot is performing network configuration, the base station network configuration status light is blinking (>3 minutes)	a. Restart the robot and configure the network app; b. Check whether the SN of the robot cleaner and the base station are the same. If they are inconsistent, you need to manually modify the base station SN to be consistent with the robot cleaner's SN through the APP; c. None of the above can solve the problem, please contact the after-sales service for repair.

Basic Specifications

Product Name	ROIDMI Self-Cleaning and Emptying Robot Vacuum	Product Model	SDJ06RM
Operating Voltage	14.8V \approx	Rated Power	48W
Battery Capacity	5200mAh	Charging limit Voltage	24V \approx 1.2A
Product Weight	About 4.2kg	Product Size	330 × 330 × 106mm
Charging Time	About 250 minutes	Noise	<77dB (A)
Dust Box Volume	About 300ml	Battery Type	lithium battery

Product Name	Base Station	Product Model	JCZ06RM
Dust Collection Power	850W	Charging Power	30W
Cleaning Power	40W	Rated Input	220-240 V-, 50-60 Hz
Rated Output	24V \approx 1.2A	Product Size	400 × 382 × 465mm
Product Weight	About 9.8kg	Noise	<86dB (A)
Dust Collection Time	About 12 seconds	Dust Bag Capacity	About 3L
Clean Water Tank Capacity	About 4L	Waste Water Tank Capacity	About 4L
Interval Between Backwashing Mop	6min. 9min. 12min 3 gears are available (APP → more Multi → base station settings → backwash frequency, adjustable frequency)		

Base Station Network Standby Power Consumption:1.68W; (Robot Vacuum+Base Station) Network Standby Power Consumption:0.90W; Enter network standby time:5min
 Frequency Range: 2400-2483.5MHz; Maximum Transmitting Power: 20dBm(EIRP)
 Class I Laser Product: DC5V,240mA,WA 800nm, IEC

Equipment requirements: support

Support devices with Android5.0 or iOS10 and above (iPhone 5 and above)

This device contains WiFi module to support 802.11 b/g/n transmission protocol

AC white power cord/L=1.35m European regulation 3*0.75mm2 H03VVF input plug 3PIN European regulation elbow / output plug 3Pin font TUV/VDE certification

Disposal

Correct disposal of this product



This marking indicates that this product should not be disposed with other household wastes throughout the EU. To prevent possible harm to the environment or human health from uncontrolled waste disposal, recycle it responsibly to promote the sustainable reuse of material resources. To return your used device, please use the return and collection systems or contact the retailer where the product was purchased. They can take this product for environmental safe recycling.

Warranty and limitations of liability

This product is guaranteed for a period of 12 months (defined by local law) from the date of purchase against any failure resulting from manufacturing or material defects.

This warranty does not cover damage caused by improper installation, improper use, or normal wear and tear of the product.

More specifically, the warranty does not cover:

- Dust bag, disposable mop, side brush, filter, mop, main brush and main brush cover are not covered by the warranty as they are consumable items;
- Damage or problems caused by improper use, accident, alteration or electrical connection of improper intensity or voltage;
- Modified products, those whose warranty seal or serial number have been damaged, altered, removed or oxidized;
- Failure of the battery due to overcharging or failure to observe the safety instructions explained in the instruction manual;
- Cosmetic damage, including scratches, dents, or any other element;
- Damage caused by any intervention carried out by an unauthorised person;
- Defects caused by normal wear and tear or due to normal ageing of the product;
- Software updates due to a change in network settings;
- Product failures due to the use of third party software to modify, change or adapt the existing software;
- Product failures caused by use without accessories approved by the manufacturer.
- Oxidised products.

Terms and conditions of implementation:

To obtain a warranty service, you are requested to return your product to the customer service desk of your retail outlet with your proof of purchase (receipt, invoice, ...), the product and its supplied accessories, with its original packaging.

It is important to have the date of purchase, the model and the serial or IMEI number on hand as information (this information usually appears on the product, the packaging or your proof of purchase).

Failing this, you must return the product with the accessories necessary for its proper operation (power supply, adaptor, etc.).

In the event that your claim is covered by the warranty, the after-sales service may, within the limits of local law, either:

- Repair or replace defective parts;
- Exchange the returned product with a product that has at least the same functionality and that is equivalent in terms of performance;
- Refund the product at the purchase price of the product mentioned on the proof of purchase.

If one of these solutions is used, this does not give rise to the extension or renewal of the warranty period.

Warranty card

Customer name		Product name and model	
Mailing address		Main unit serial number	
Contact information		Purchase date	

This warranty card contains customers' personal information, keep it safe

Maintenance records

Servicing center	Fault description	Replacement parts	Servicing engineer	Servicing date



Our products and packaging are recyclable, do not throw them away!
Find where to drop them off on the website www.quefairedemesdechets.fr



Correct disposal
of this product



for indoor
use only

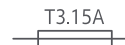

protection
fuse: T 3.15A

Scan the QR code for manuals
in multiple languages

Manufacturer:ROIDMI INFORMATION TECHNOLOGY CO., LTD.

Address:4F,C8 BUILDING,NO.1699 HUIZHAN ROAD,LIFE SCIENCE AND TECHNOLOGY PARK,HUIZHAN DISTRICT, WUXI,JIANGSU,PRC

Executive standards:

(EC) 1275/2008: 2008-12-17 Amended by (EC) 278/2009:2009-04-06, (EC) 642/2009:2009-07-22, (EU) 617/2013:2013-06-26; (EU) 801/2013:2013-08-22, EN 50564:2011

EN 60335-1:2012/A15:2021, EN 60335-2-2:2010/A1:2013, EN 60335-2-29:2004/A11:2018, EN 62233:2008

EN 55014-1:2017/A11:2020, EN IEC 55014-1:2021, EN 55014-2:2015, EN IEC 55014-2:2021, EN 61000-3-2:2014, EN IEC 61000-3-2:2019/A1:2021, EN 61000-3-3:2013, EN 61000-3-3:2013/A1:2019

EN 301 489-1 V2.2.3:2019, EN 301 489-17 V3.2.4:2020

EN 300 328 V2.2:2019, EN IEC 62311:2020, EN 50665:2017

2011/65/EU

Service email: service@roidmi.com

Website: www.roidmi.com/en

No.02.2022

Only applicable to the robot vacuum and mop cleaner model SDJ06RM

Made in China